

# Silicon Diode

## **BY459-1500**

1500V/12A

# DATASHEET

OEM – Philips

Source: Philips Databook 1999

## Damper diode fast, high-voltage

**BY459-1500, BY459-1500S**

### FEATURES

- Low forward volt drop
- Fast switching
- Soft recovery characteristic
- High thermal cycling performance
- Low thermal resistance

### SYMBOL

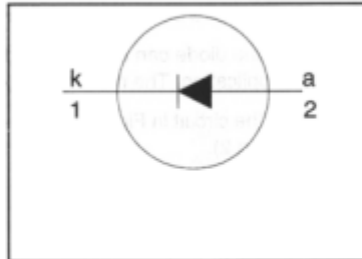

### QUICK REFERENCE DATA

$V_R = 1500 \text{ V}$
$V_F \leq 1.2 \text{ V} / 1.25 \text{ V}$
$I_{F(\text{peak})} = 12 \text{ A} (f = 48 \text{ kHz})$
$I_{F(\text{peak})} = 10 \text{ A} (f = 82 \text{ kHz})$
$I_{FSM} \leq 100 \text{ A}$
$t_{rr} \leq 350 \text{ ns} / 220 \text{ ns}$

### GENERAL DESCRIPTION

Glass-passivated double diffused rectifier diode featuring fast forward recovery and low forward recovery voltage. The device is intended for use in HDTV receivers and multi-sync monitor horizontal deflection circuits.

The BY459 series is supplied in the conventional leaded SOD59 (TO220AC) package.

### PINNING

PIN	DESCRIPTION
1	cathode
2	anode
tab	cathode

### SOD59 (TO220AC)

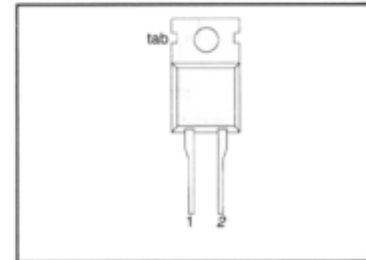

### LIMITING VALUES

Limiting values in accordance with the Absolute Maximum System (IEC 134).

SYMBOL	PARAMETER	CONDITIONS	MIN.	MAX.	UNIT
$V_{RSM}$	Peak non-repetitive reverse voltage		-	1500	V
$V_{RRM}$	Peak repetitive reverse voltage		-	1500	V
$V_{RWM}$	Crest working reverse voltage		-	1300	V
$I_{F(\text{peak})}$	Peak working forward current	$f = 48 \text{ kHz};$ $f = 82 \text{ kHz};$	-	-1500	A
			12	-1500S	A
$I_{FRM}$	Peak repetitive forward current	$t = 100 \mu\text{s}$	-	100	A
$I_{F(\text{RMS})}$	RMS forward current		-	30	A
$I_{FSM}$	Peak non-repetitive forward current	$t = 10 \text{ ms}$	-	100	A
		$t = 8.3 \text{ ms}$ sinusoidal; $T_j = 150 \text{ }^\circ\text{C}$ prior to surge; with reapplied $V_{RWM(\text{max})}$	-	110	A
$T_{stg}$	Storage temperature		-40	150	$^\circ\text{C}$
$T_j$	Operating junction temperature		-	150	$^\circ\text{C}$

Damper diode  
fast, high-voltage

BY459-1500, BY459-1500S

### THERMAL RESISTANCES

SYMBOL	PARAMETER	CONDITIONS	MIN.	TYP.	MAX.	UNIT
$R_{thj-mb}$	Thermal resistance junction to mounting base	in free air	-	-	1.5	K/W
$R_{thj-a}$	Thermal resistance junction to ambient		-	60	-	K/W

### STATIC CHARACTERISTICS

$T_j = 25\text{ }^\circ\text{C}$  unless otherwise stated

SYMBOL	PARAMETER	CONDITIONS	TYP.		MAX.		UNIT
			1500	1500S	1500	1500S	
$V_F$	Forward voltage	<b>BY459</b> $I_F = 6.5\text{ A}$ $I_F = 6.5\text{ A}; T_j = 125\text{ }^\circ\text{C}$	0.95	1.05	1.30	1.35	V
$I_R$	Reverse current	$V_R = 1300\text{ V}$ $V_R = 1300\text{ V}; T_j = 125\text{ }^\circ\text{C}$	-	250	-	250	$\mu\text{A}$ mA

### DYNAMIC CHARACTERISTICS

$T_j = 25\text{ }^\circ\text{C}$  unless otherwise stated

SYMBOL	PARAMETER	CONDITIONS	TYP.		MAX.		UNIT
			1500	1500S	1500	1500S	
$t_{rr}$	Reverse recovery time	<b>BY459</b> $I_F = 1\text{ A}, V_R \geq 30\text{ V};$	0.25	0.17	0.35	0.22	$\mu\text{s}$
$Q_r$	Reverse recovery charge	$I_F = 2\text{ A}, -di_F/dt = 20\text{ A}/\mu\text{s}$	2.0	0.70	3.0	0.95	$\mu\text{C}$
$V_{rr}$	Peak forward recovery voltage	$I_F = 6.5\text{ A}, di_F/dt = 50\text{ A}/\mu\text{s}$	8.0	11.0	14.0	19.0	V
$t_f$	Forward recovery time	$I_F = 6.5\text{ A}, di_F/dt = 50\text{ A}/\mu\text{s}$	170	200	250	300	ns

Damper diode  
fast, high-voltage

BY459-1500, BY459-1500S

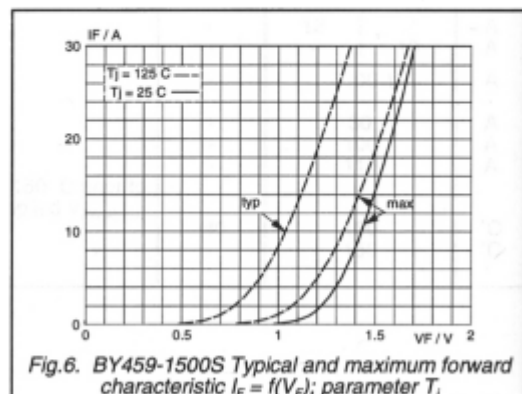
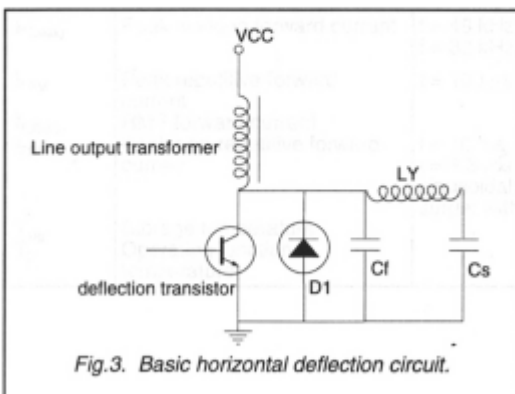
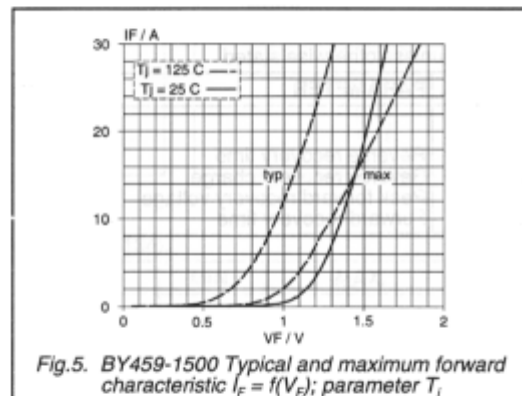
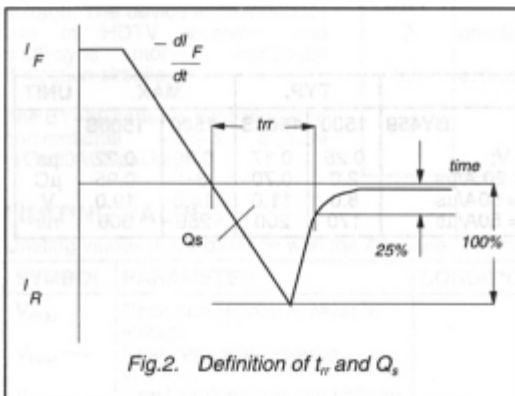
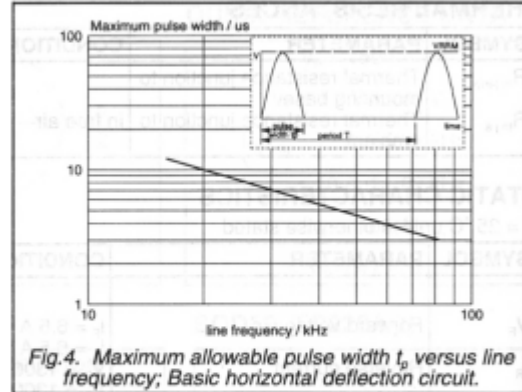
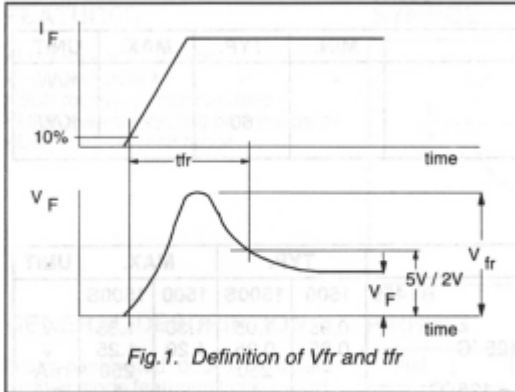

**Damper diode  
fast, high-voltage**

BY459-1500, BY459-1500S

