

UHF Amplifier Module

BGY113E

3,5W UHF Amplifier

DATASHEET

OEM – Philips

Source: Philips Data Handbook SC09

RF Power Modules and Transistors for Mobile Phones 1996

UHF amplifier modules**BGY113E; BGY113F; BGY113G****FEATURES**

- 6 V nominal supply voltage
- 3.5 W output power
- Easy control of output power by DC voltage.

APPLICATIONS

- Hand-held communication equipment operating in the 400 to 440 MHz, 430 to 470 MHz and 470 to 520 MHz frequency ranges.

DESCRIPTION

The BGY113E, BGY113F and BGY113G are four-stage UHF amplifier modules in a 7-lead SOT288D package. The modules consist of four NPN silicon planar transistor dies mounted together with matching and bias circuit components on a metallized ceramic substrate. The modules produce an output power of 3.5 W into a load of 50 Ω with an RF drive power of 1 mW.

PINNING - SOT288D

PIN	DESCRIPTION
1	RF input
2	V _{S1}
3	V _C
4	V _{S2}
5	V _{S3}
6	V _{S4}
7	RF output
Flange	ground

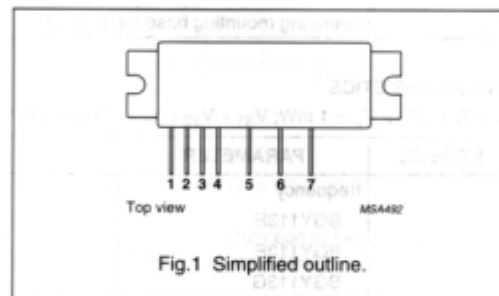
**QUICK REFERENCE DATA**

RF performance at $T_{mb} = 25\text{ }^{\circ}\text{C}$.

TYPE NUMBER	MODE OF OPERATION	f (MHz)	V _S (V)	P _L (W)	G _P (dB)	η (%)	Z _S , Z _L (Ω)
BGY113E	CW	400 to 440	6	3.5	≥ 35.5	≥ 40	50
BGY113F	CW	430 to 470	6	3.5	≥ 35.5	≥ 40	50
BGY113G	CW	470 to 520	6	3.5	≥ 35.5	≥ 38	50

WARNING**Product and environmental safety - toxic materials**

This product contains beryllium oxide. The product is entirely safe provided that the BeO discs are not damaged. All persons who handle, use or dispose of this product should be aware of its nature and of the necessary safety precautions. After use, dispose of as chemical or special waste according to the regulations applying at the location of the user. It must never be thrown out with the general or domestic waste.

UHF amplifier modules

BGY113E; BGY113F; BGY113G

LIMITING VALUES

In accordance with the Absolute Maximum Rating System (IEC 134).

SYMBOL	PARAMETER	MIN.	MAX.	UNIT
V_{S1}	DC supply voltage	–	9	V
V_{S2}	DC supply voltage	–	9	V
V_{S3}	DC supply voltage	–	9	V
V_{S4}	DC supply voltage	–	9	V
V_C	DC control voltage	–	7.5	V
P_D	input drive power	–	5	mW
P_L	load power	–	4	W
T_{stg}	storage temperature	–40	+100	°C
T_{mb}	operating mounting base temperature	–30	+90	°C

CHARACTERISTICS

 $Z_S = Z_L = 50 \Omega$; $P_D = 1$ mW; $V_{S1} = V_{S2} = V_{S3} = V_{S4} = 6$ V; $V_C \leq 6$ V; $T_{mb} = 25$ °C; unless otherwise specified.

SYMBOL	PARAMETER	CONDITIONS	MIN.	TYP.	MAX.	UNIT
f	frequency					
	BGY113E		400	–	440	MHz
	BGY113F		430	–	470	MHz
	BGY113G		470	–	520	MHz
$I_{Q3} + I_{Q4}$	total leakage current	$V_{S1} = V_{S2} = V_C = 0$; $P_D = 0$	–	–	0.2	mA
P_L	load power	$V_C = 6$ V	3.5	–	–	W
G_p	power gain	adjust V_C for $P_L = 3.5$ W	35.5	–	–	dB
η	efficiency	adjust V_C for $P_L = 3.5$ W				
	BGY113E		40	45	–	%
	BGY113F		40	45	–	%
	BGY113G		38	43	–	%
H_2	second harmonic	adjust V_C for $P_L = 3.5$ W	–	–	–40	dBc
H_3	third harmonic	adjust V_C for $P_L = 3.5$ W	–	–	–40	dBc
$V_{SWR_{in}}$	input VSWR	adjust V_C for $P_L = 3.5$ W	–	–	2 : 1	
	control range	$V_C = 0$ to 6 V; $P_D = 1$ mW	10	–	–	dB
	stability	$P_D = 0.5$ to 2 mW; $V_{S1} = V_{S2} = V_{S3} = V_{S4} = 5$ to 9 V; $V_C = 0$ to 6 V; adjust V_C for $P_L \leq 4$ W; $V_{SWR} \leq 6 : 1$ through all phases	–	–	–60	dBc
	ruggedness	$V_{S1} = V_{S2} = V_{S3} = V_{S4} = 9$ V; adjust V_C for $P_L = 4$ W; $V_{SWR} \leq 10 : 1$ through all phases	no degradation			

UHF amplifier modules

BGY113E; BGY113F; BGY113G

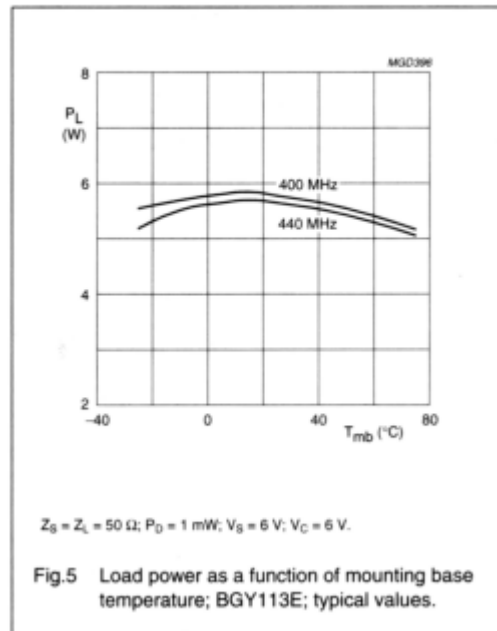
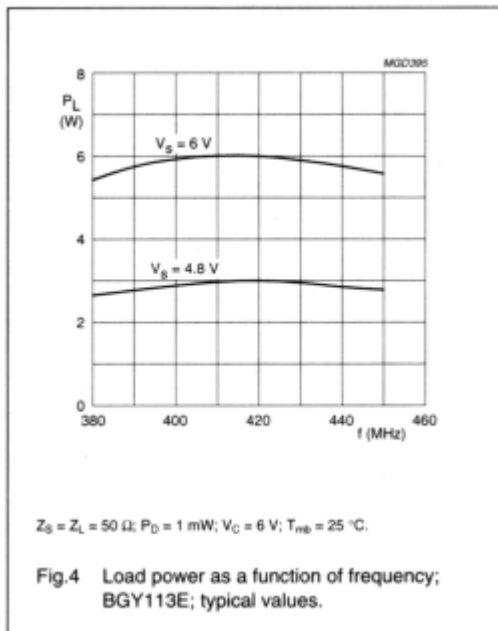
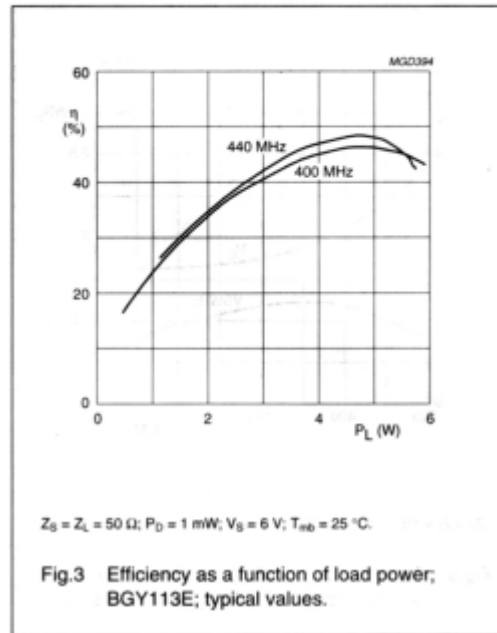
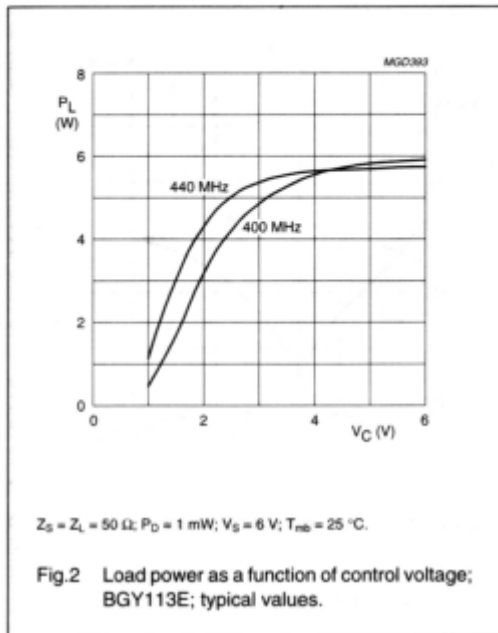

UHF amplifier modules

BGY113E; BGY113F; BGY113G

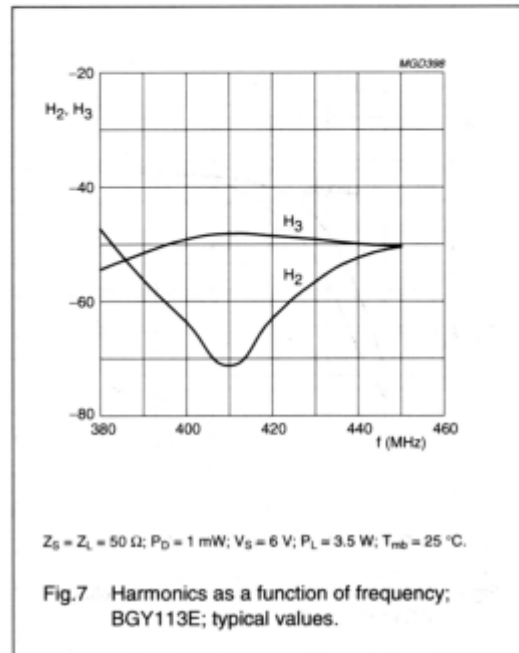
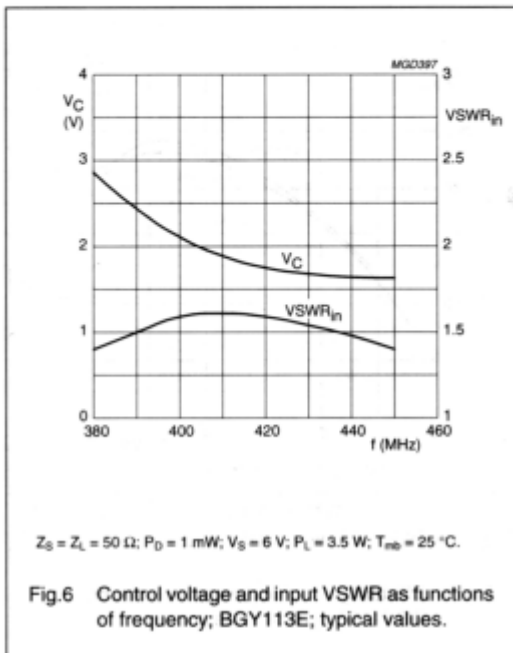

UHF amplifier modules

BGY113E; BGY113F; BGY113G

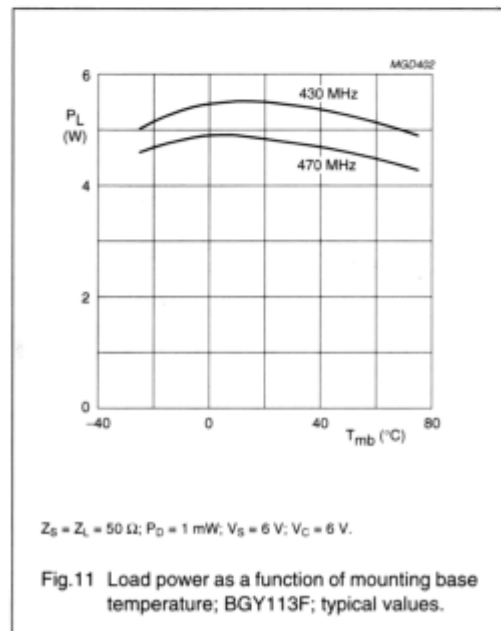
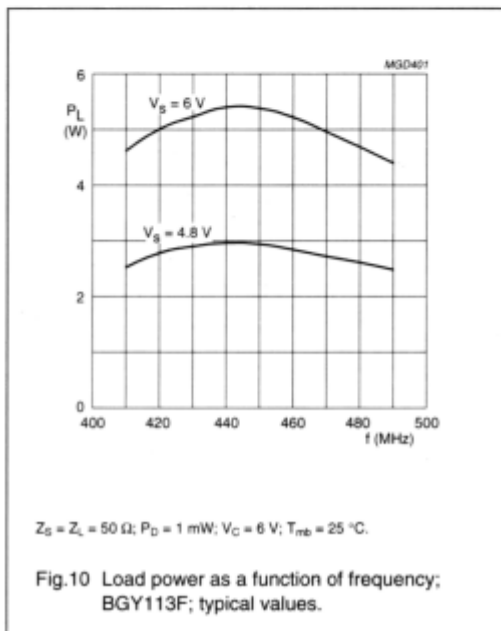
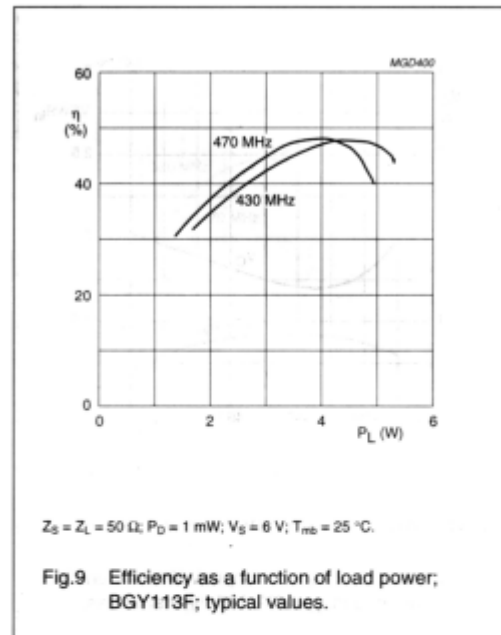
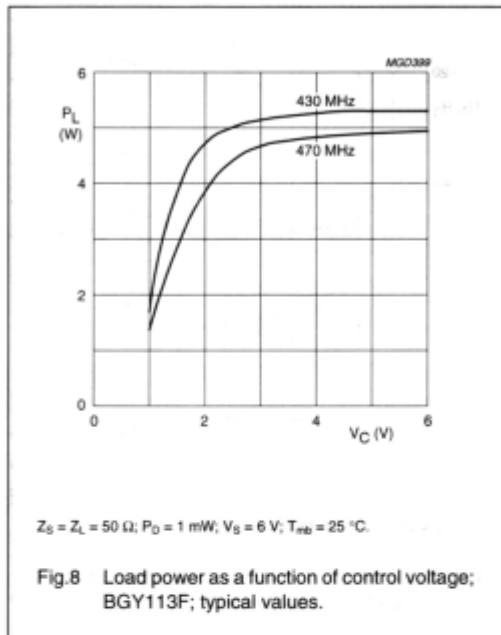

UHF amplifier modules

BGY113E; BGY113F; BGY113G

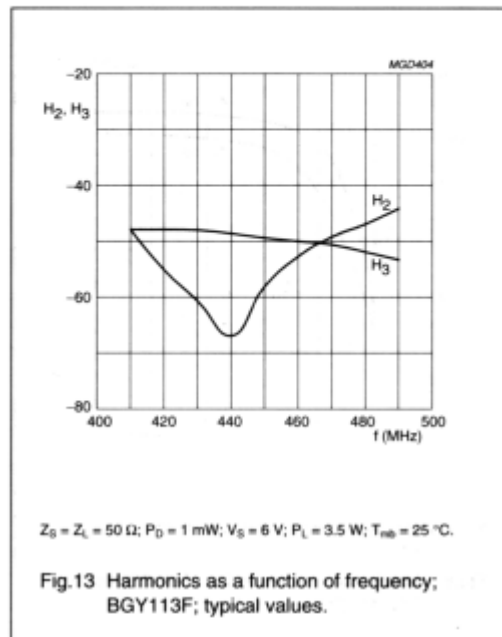
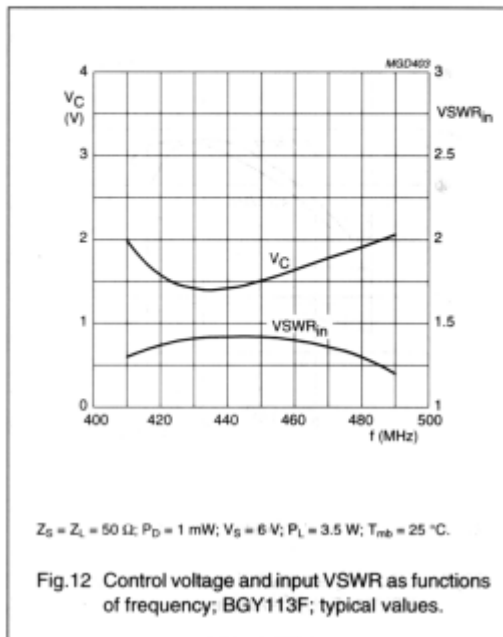

UHF amplifier modules

BGY113E; BGY113F; BGY113G

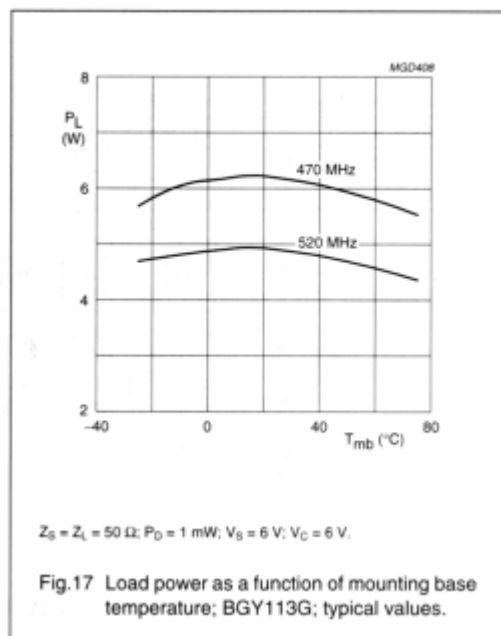
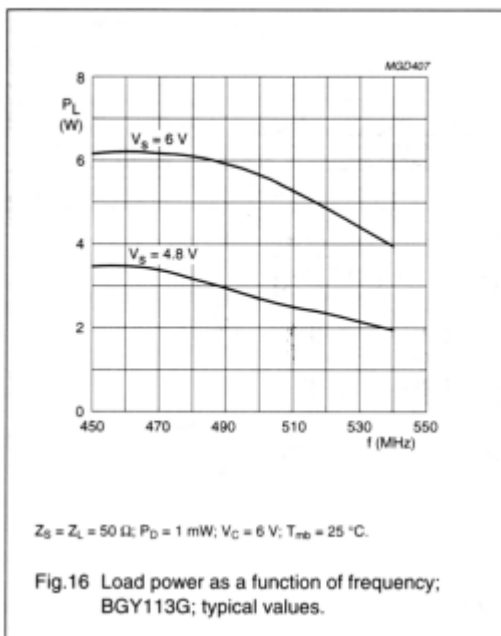
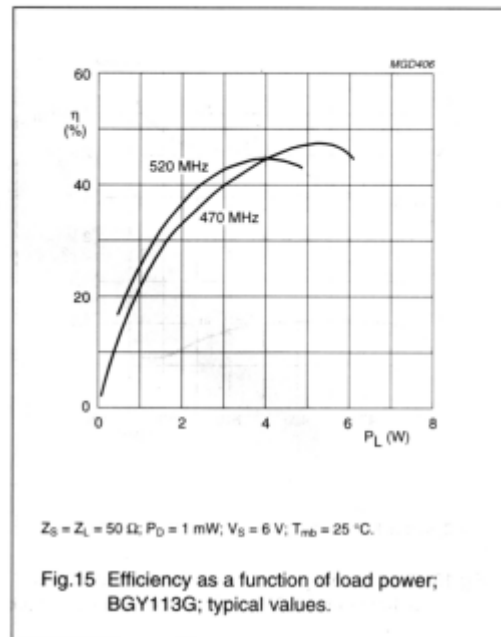
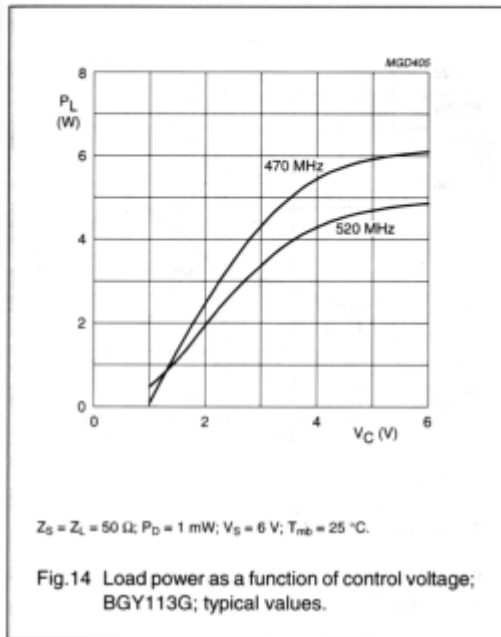

UHF amplifier modules

BGY113E; BGY113F; BGY113G

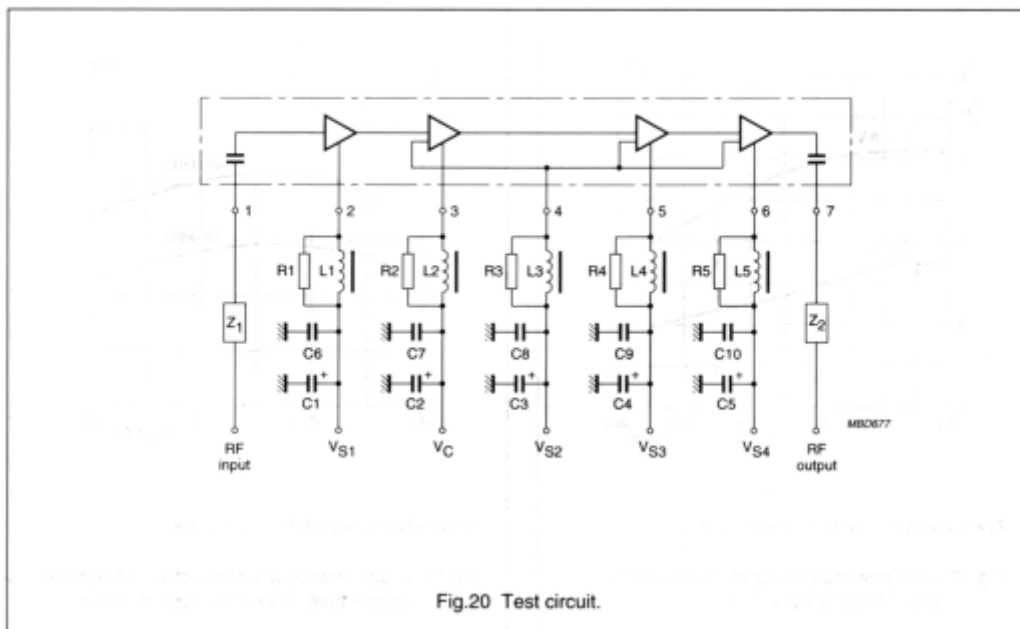
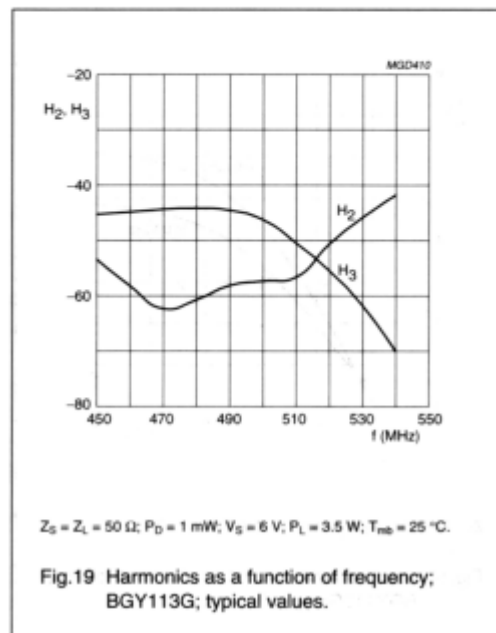
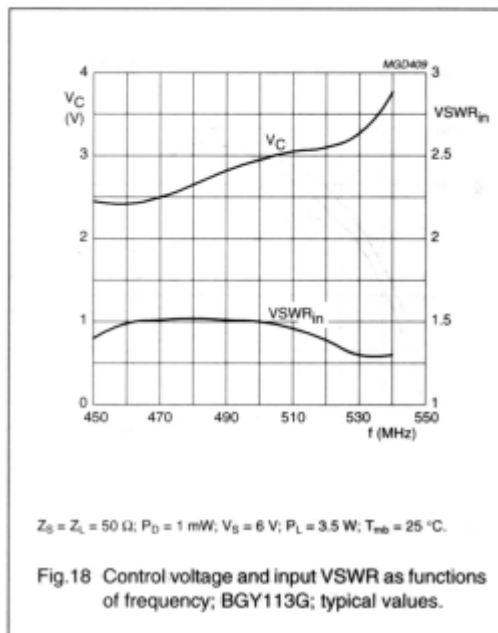

UHF amplifier modules

BGY113E; BGY113F; BGY113G

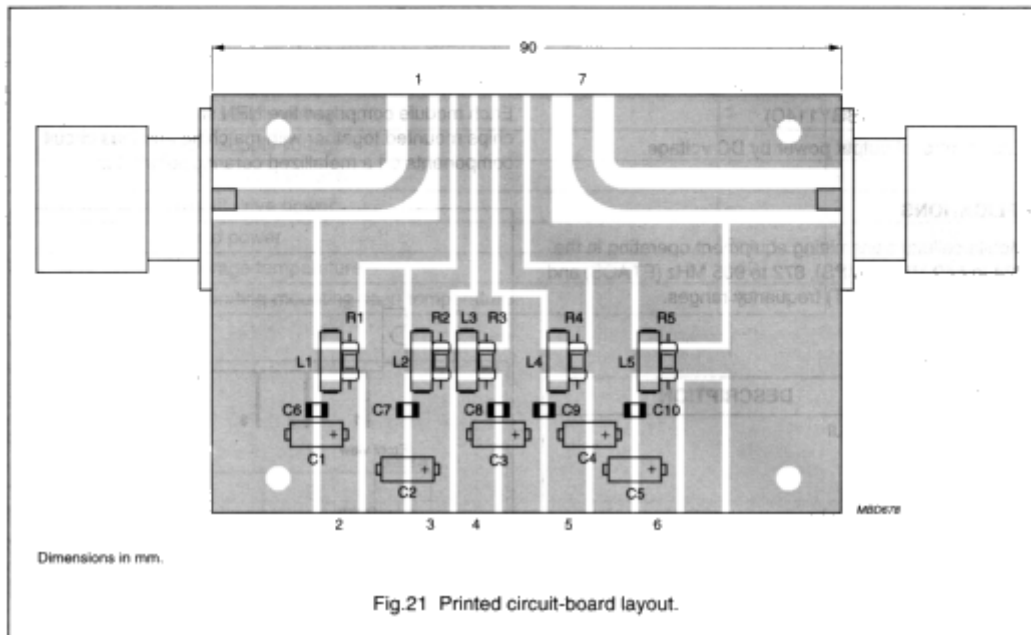

List of components (see Figs 20 and 21)

COMPONENT	DESCRIPTION	VALUE	CATALOGUE NO.
C1, C2, C3, C4, C5	electrolytic capacitor	1 μ F; 63 V	2222 085 68108
C6, C7, C8, C9, C10	multilayer ceramic chip capacitor; X7R, 0805	18 nF	2222 910 16739
L1, L2, L3, L4, L5	Grade 4S2 Ferroxcube bead		4330 030 36300
R1, R2, R3, R4, R5	metal film resistor	0.4 W; 10 Ω	2322 195 13109
Z ₁ , Z ₂	stripline; note 1	50 Ω	—

Note

- The striplines are on a double copper-clad printed circuit-board with epoxy dielectric ($\epsilon_r = 4.7$); thickness = $\frac{1}{16}$ inch.