

UHF Amplifier Module

BGY110G

902-928MHz UHF Amplifier

DATASHEET

OEM – Philips

Source: Philips Data Handbook SC09

RF Power Modules and Transistors for Mobile Phones 1996

UHF amplifier modules**BGY110D; BGY110E;
BGY110F; BGY110G****FEATURES**

- 7.2 V nominal supply voltage
- 1.7 W output power
- Easy control of output power by DC voltage.

APPLICATIONS

- Hand-held transmitting equipment operating in the 824 to 849 MHz, 872 to 905 MHz, 890 to 915 MHz and 902 to 928 MHz frequency ranges respectively.

DESCRIPTION

The BGY110D, 110E, 110F and 110G are four-stage UHF amplifier modules in a SOT246 package. Each module consists of four NPN silicon planar transistor dies, mounted together with matching and bias circuit components on a metallized ceramic substrate.

PINNING - SOT246

PIN	DESCRIPTION
1	RF input/ V_C
2	V_{S1}
3	V_{S2}
4	V_{S3}
5	RF output
Flange	ground

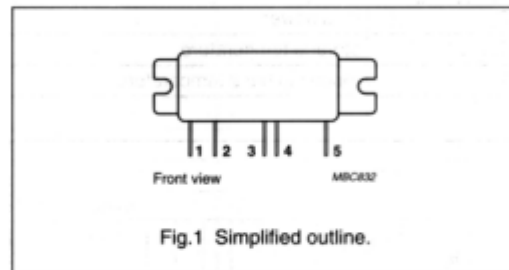
**QUICK REFERENCE DATA**

RF performance at $T_{mb} = 25\text{ }^{\circ}\text{C}$.

TYPE NUMBER	MODE OF OPERATION	f (MHz)	V_S (V)	V_C (V)	P_L (W)	G_p (dB)	η (%)	$Z_S; Z_L$ (Ω)
BGY110D	CW	824 to 849	7.2	4.5	1.7	≥ 32.3	≥ 39	50
BGY110E	CW	872 to 905	7.2	4.5	1.7	≥ 32.3	≥ 39	50
BGY110F	CW	890 to 915	7.2	4.5	1.7	≥ 32.3	≥ 39	50
BGY110G	CW	902 to 928	7.2	4.5	1.7	≥ 32.3	≥ 39	50

UHF amplifier modules

BGY110D; BGY110E;
BGY110F; BGY110G**LIMITING VALUES**

In accordance with the Absolute Maximum Rating System (IEC 134).

SYMBOL	PARAMETER	MIN.	MAX.	UNIT
V_{S1}	DC supply voltage	-	10	V
V_{S2}	DC supply voltage	-	10	V
V_{S3}	DC supply voltage	-	10	V
V_C	DC control voltage	-	4.5	V
$+V_o$	RF output terminal voltage	-	25	V
P_D	input drive power	-	3	mW
P_L	load power	-	2.25	W
T_{stg}	storage temperature	-40	+100	°C
T_{mb}	mounting base temperature	-	90	°C

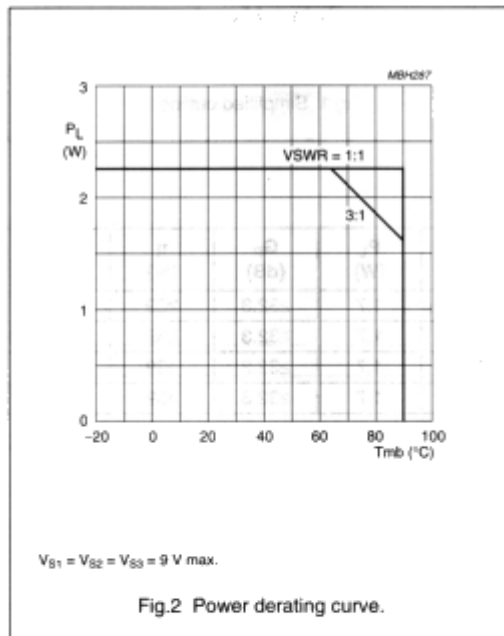

UHF amplifier modules

BGY110D; BGY110E;
BGY110F; BGY110G

CHARACTERISTICS

 $Z_S = Z_L = 50 \Omega$; $V_{S1} = V_{S2} = V_{S3} = 7.2 \text{ V}$; $V_C = 4.5 \text{ V}$; $T_{mb} = 25 \text{ }^\circ\text{C}$; unless otherwise specified.

SYMBOL	PARAMETER	CONDITIONS	MIN.	TYP.	MAX.	UNIT
f	frequency					
	BGY110D		824	–	849	MHz
	BGY110E		872	–	905	MHz
	BGY110F		890	–	915	MHz
	BGY110G		902	–	928	MHz
I_{C2}	leakage current	$V_{S1} = V_C = 0$	–	–	100	μA
I_{C3}	leakage current	$V_{S1} = V_C = 0$	–	–	100	μA
P_L	load power	$P_D = 1 \text{ mW}$	1.7	–	–	W
η	efficiency	$P_L = 1.7 \text{ W}$	39	–	–	%
H_2	second harmonic	$P_L = 1.7 \text{ W}$	–	–	–40	dB
H_3	third harmonic	$P_L = 1.7 \text{ W}$	–	–	–45	dB
VSWR _{in}	input VSWR	$P_L = 1.7 \text{ W}$	–	–	2:1	
ΔG_p	gain control	$V_C = 0 \text{ to } 4.5 \text{ V}$; $P_D = 1 \text{ mW}$	30	–	–	dB
P_L	output switching power	$V_{S1} = V_C = 0$; $P_D = 1 \text{ mW}$	–	–	–20	dBm
	stability	$P_D = 0.5 \text{ to } 2 \text{ mW}$; $V_{S1} = V_{S2} = V_{S3} = 6 \text{ to } 9 \text{ V}$; $V_C = 0 \text{ to } 4.5 \text{ V}$; $P_L \leq 2 \text{ W}$; $VSWR \leq 6 : 1$	–	–	–60	dBc
P_n	noise power	30 kHz bandwidth; $P_L = 1.7 \text{ W}$; 45 MHz above f_0	–	–84	–80	dBm
	ruggedness	$P_D = 1 \text{ mW}$; $V_{S1} = V_{S2} = V_{S3} = 9 \text{ V}$; $P_L \leq 1.8 \text{ W}$; $VSWR = 10 : 1$ through all phases;	no degradation			

UHF amplifier modules

BGY110D; BGY110E;
BGY110F; BGY110G

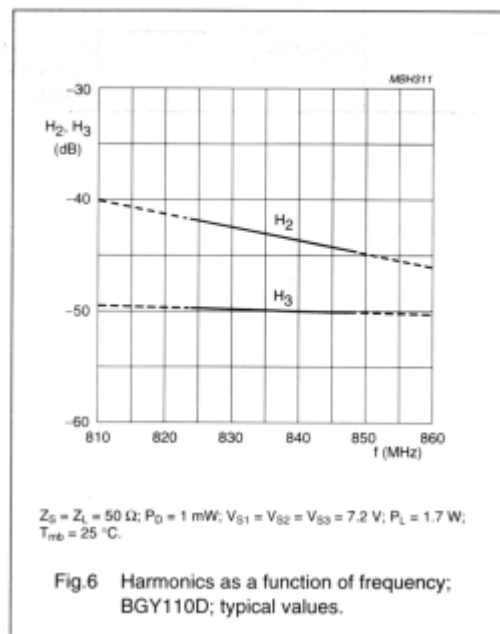
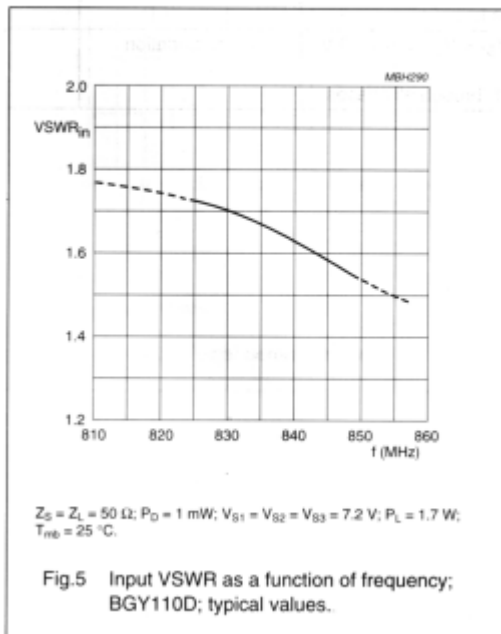
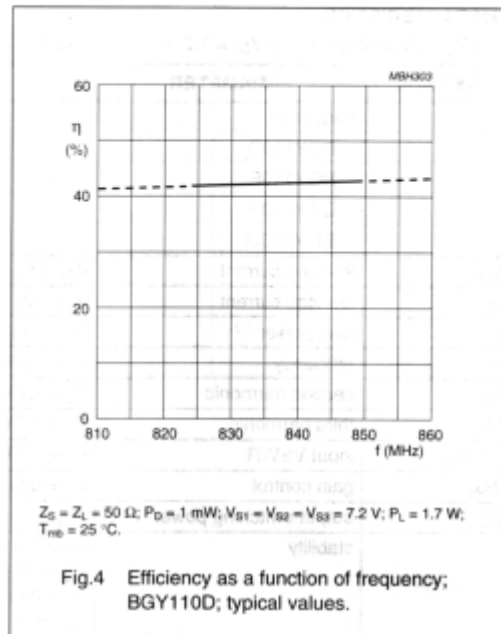
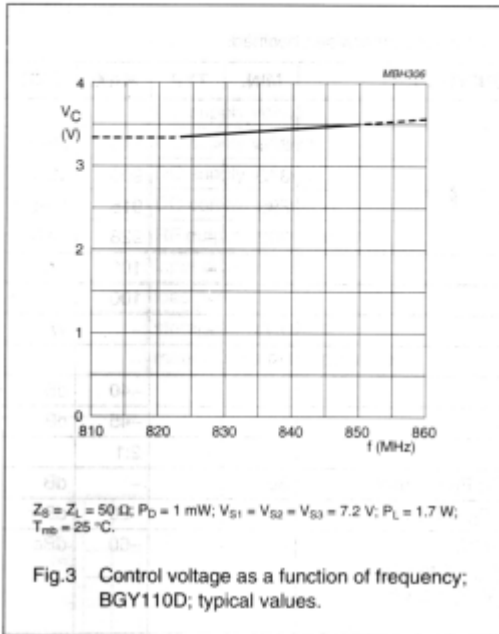

UHF amplifier modules

BGY110D; BGY110E;
BGY110F; BGY110G

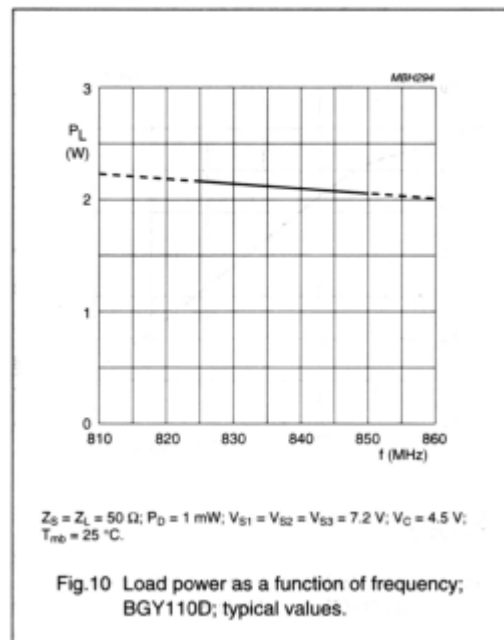
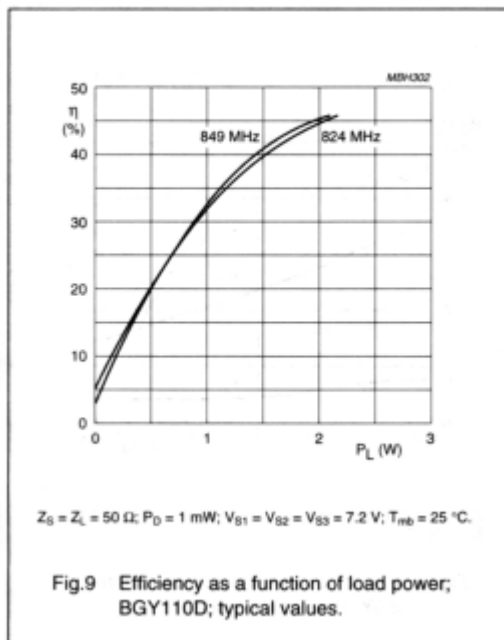
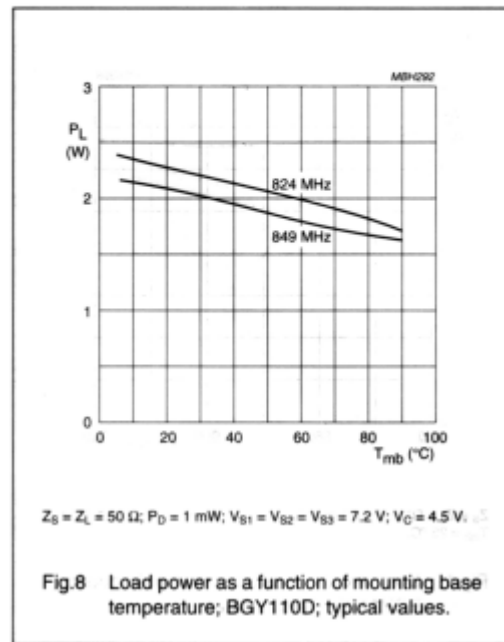
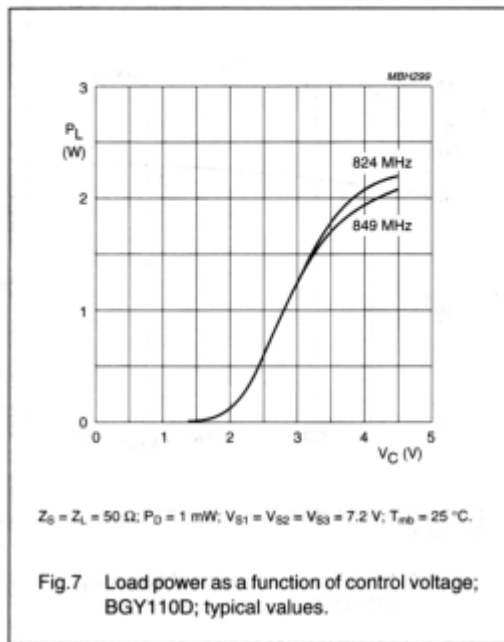

UHF amplifier modules

BGY110D; BGY110E;
BGY110F; BGY110G

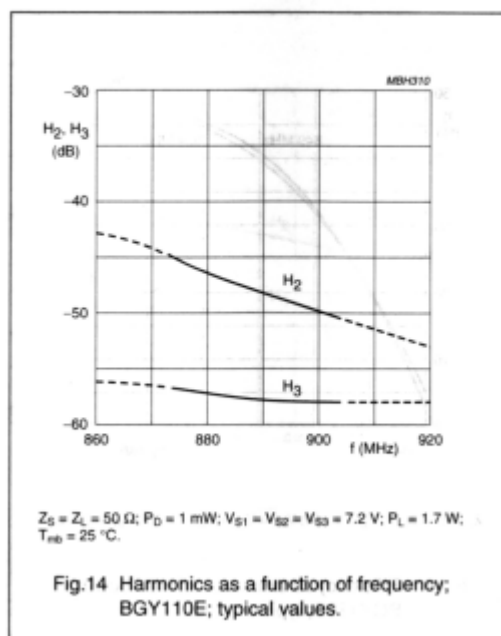
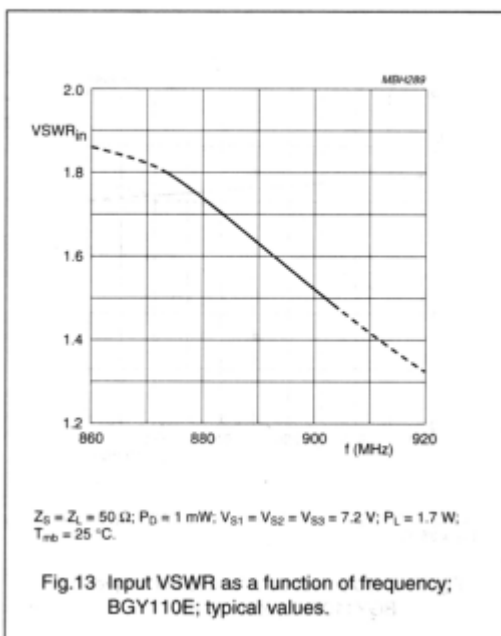
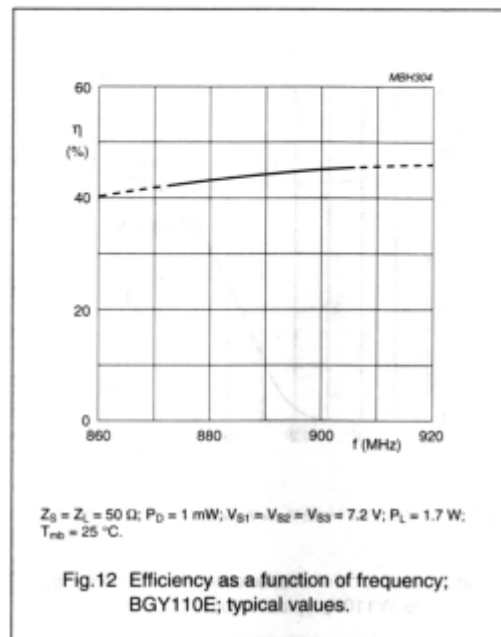
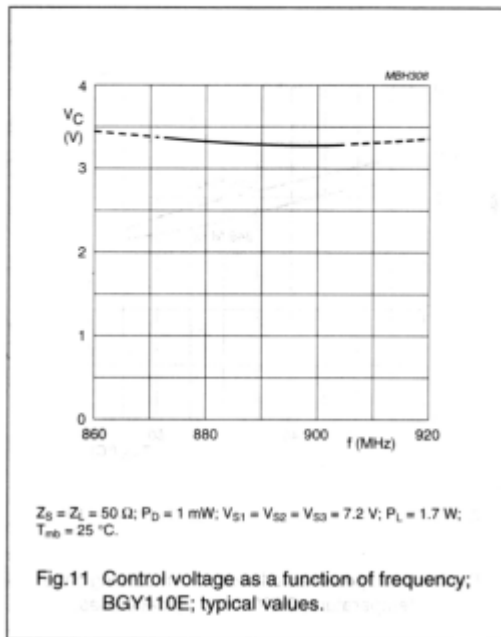

UHF amplifier modules

BGY110D; BGY110E;
BGY110F; BGY110G

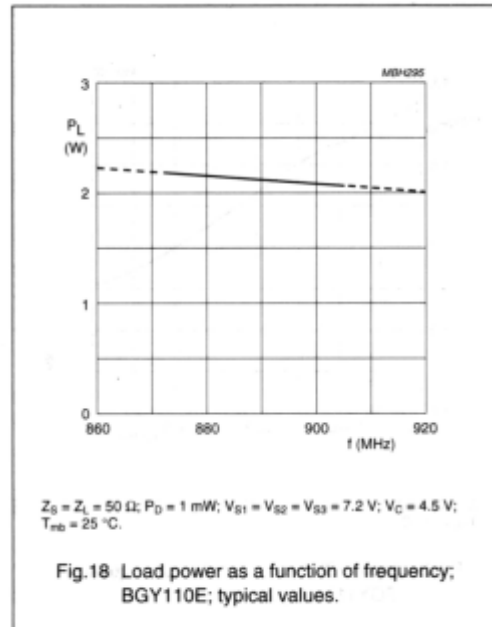
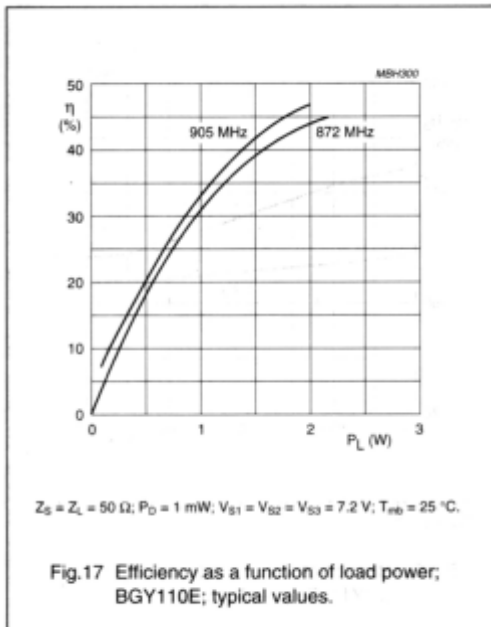
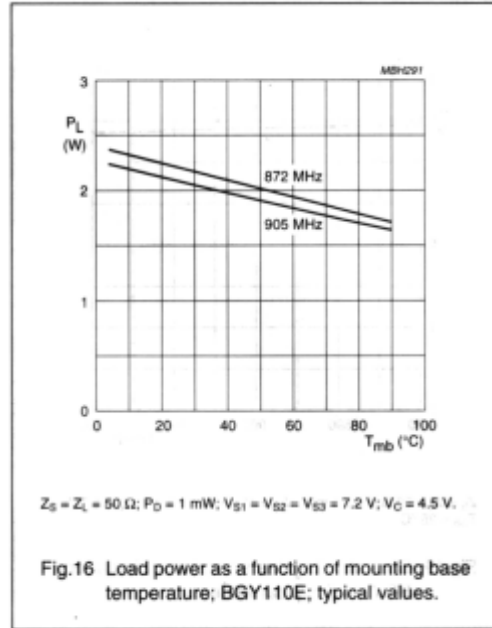
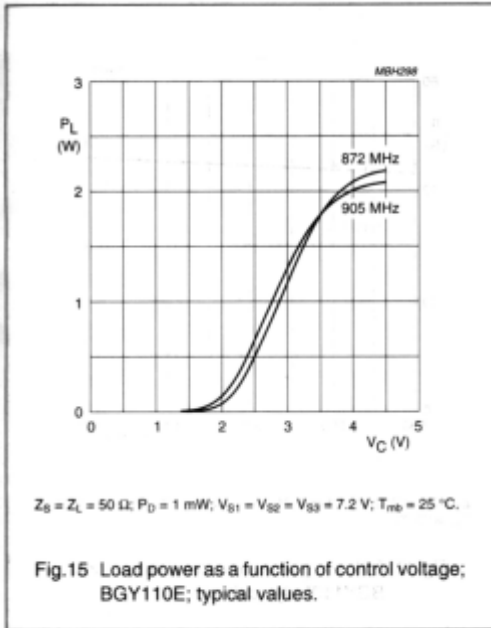

UHF amplifier modules

BGY110D; BGY110E;
BGY110F; BGY110G

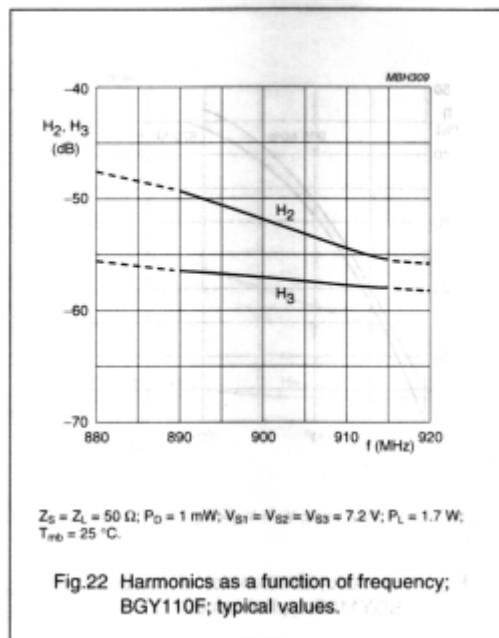
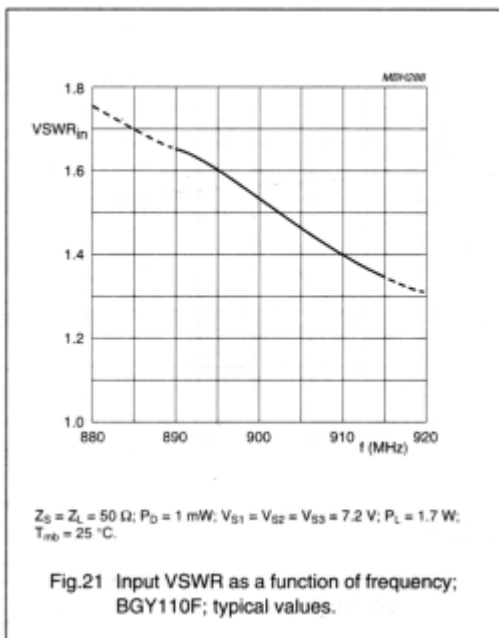
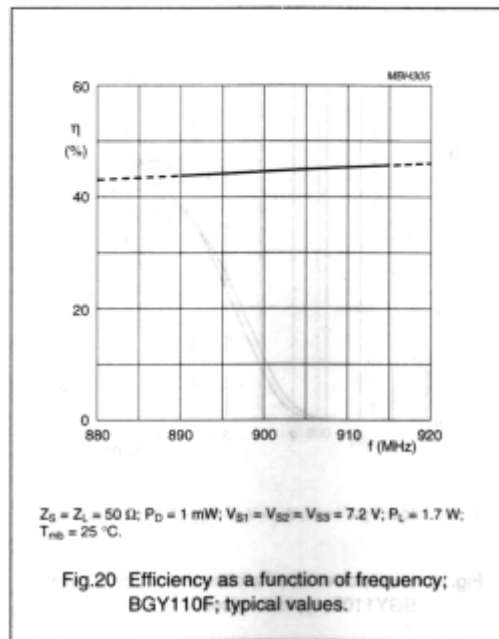
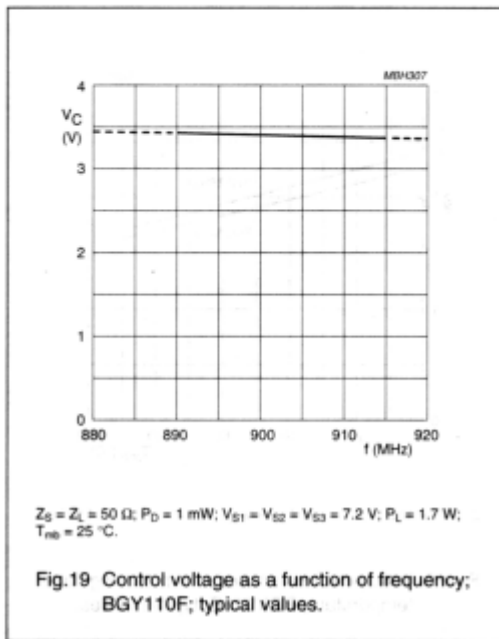

UHF amplifier modules

BGY110D; BGY110E;
BGY110F; BGY110G

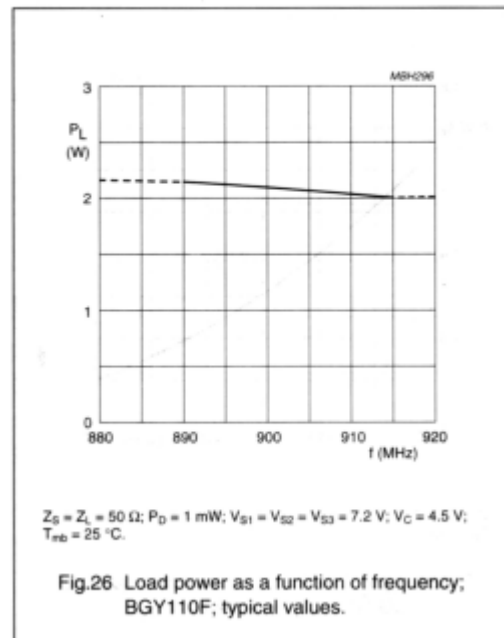
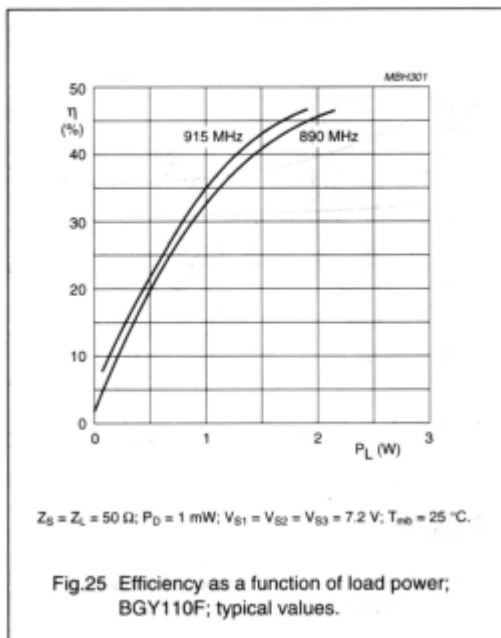
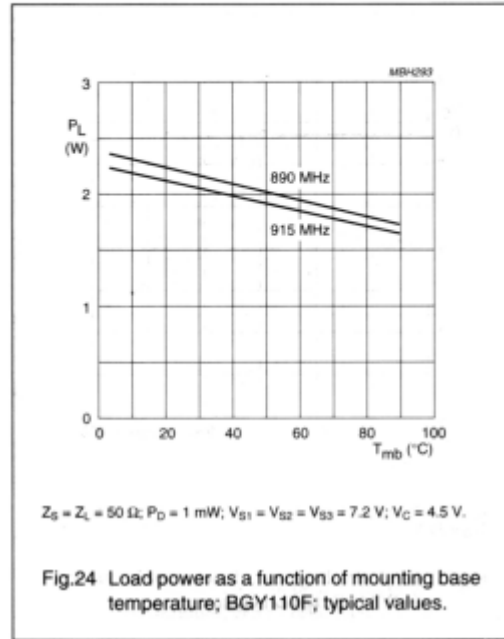
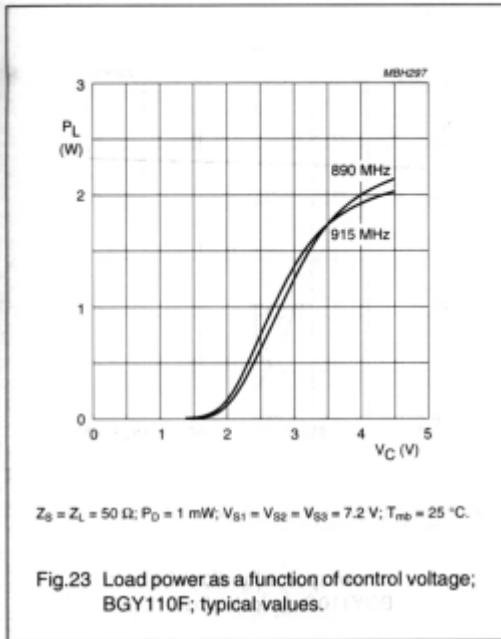

UHF amplifier modules

BGY110D; BGY110E;
BGY110F; BGY110G

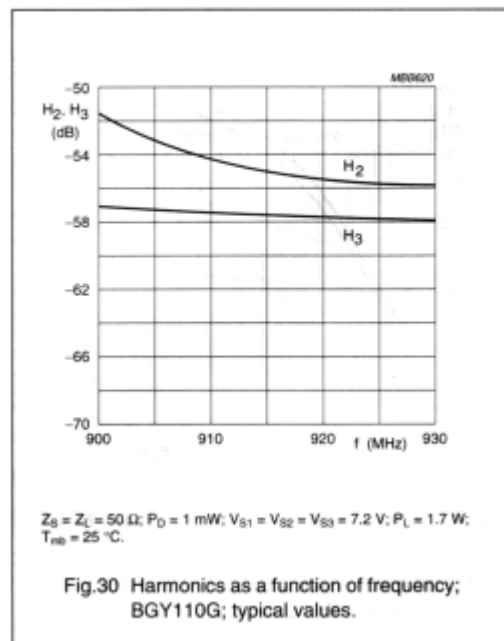
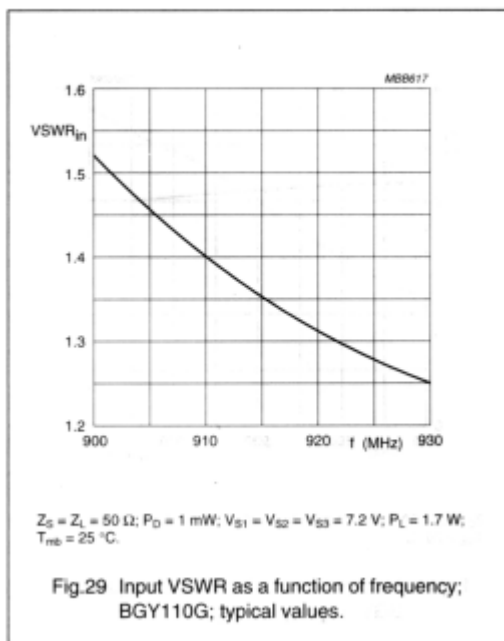
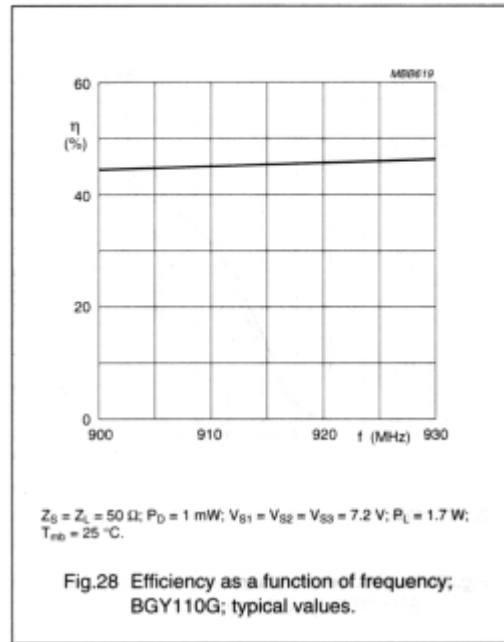
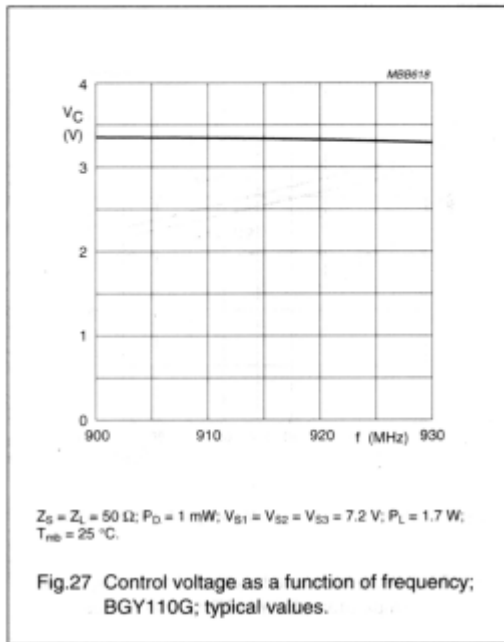

UHF amplifier modules

BGY110D; BGY110E;
BGY110F; BGY110G

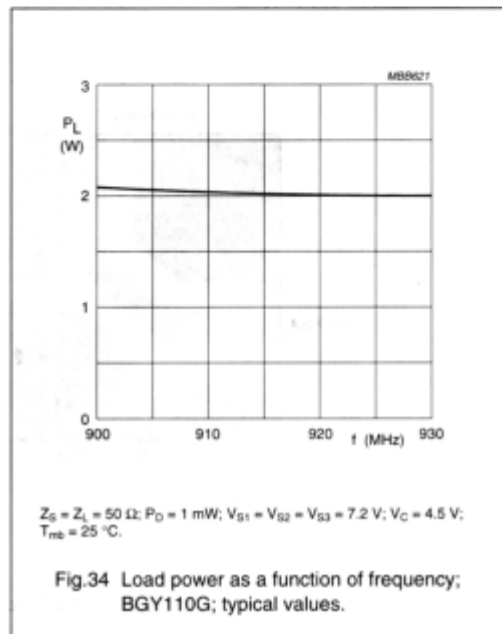
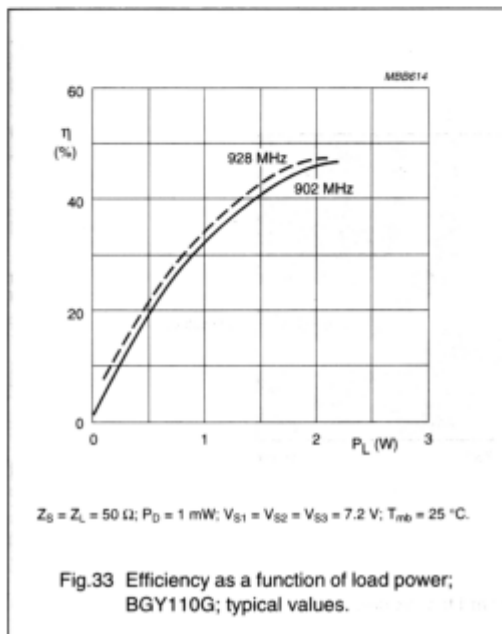
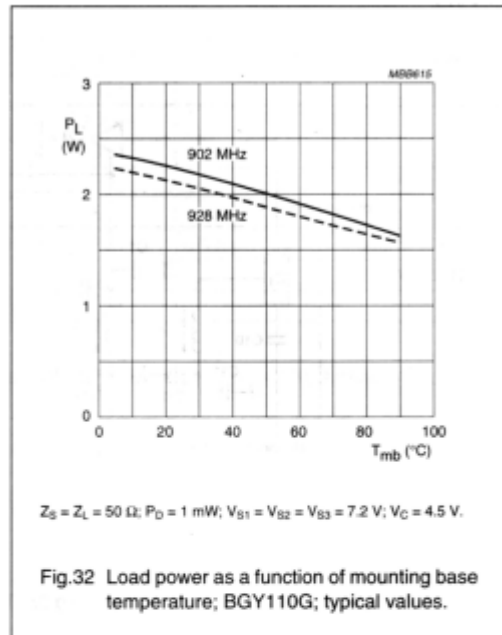
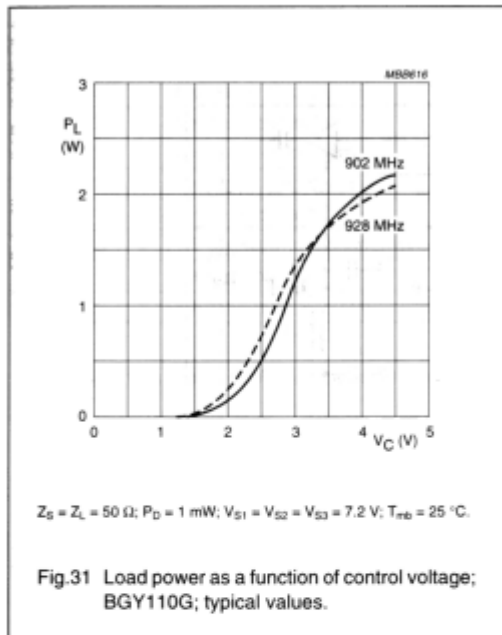

UHF amplifier modules

BGY110D; BGY110E;
BGY110F; BGY110G

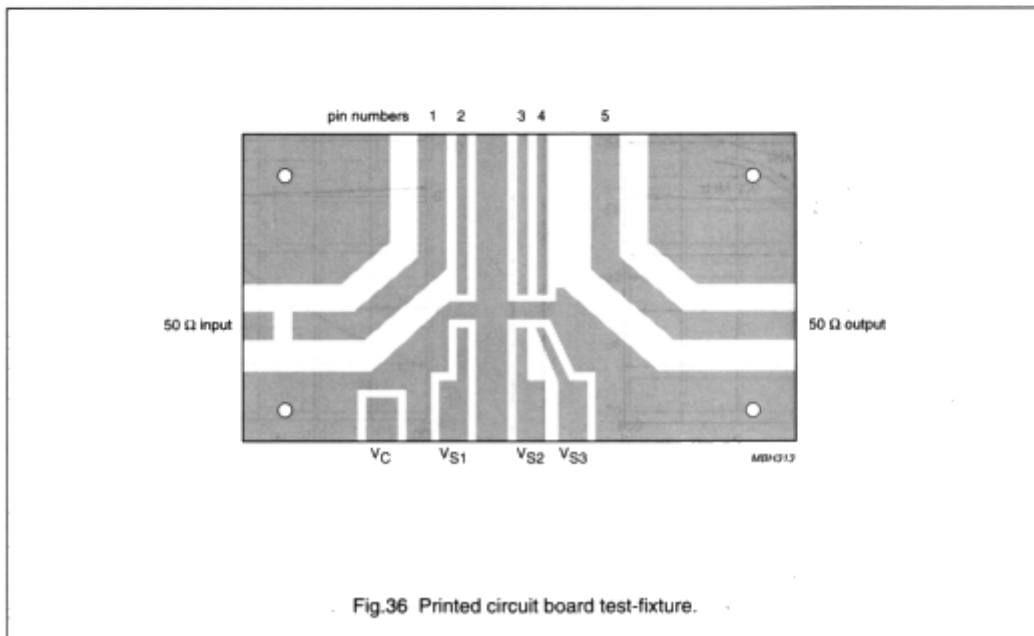
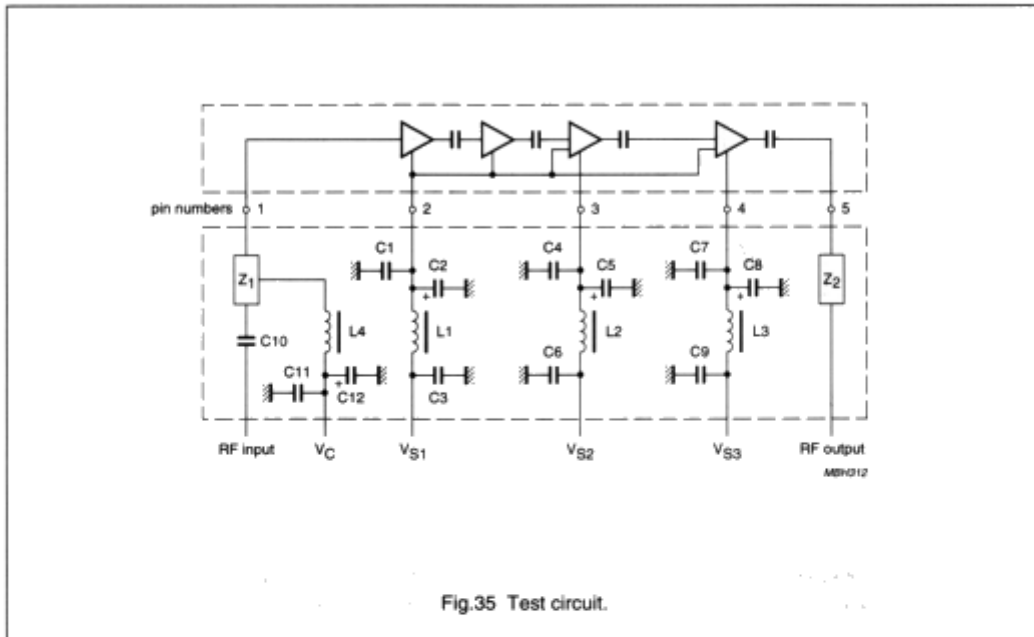

Philips Semiconductors

Product specification

UHF amplifier modules

BGY110D; BGY110E;
BGY110F; BGY110G**List of components** (see Fig.35)

COMPONENT	DESCRIPTION	VALUE	DIMENSIONS	CATALOGUE NO.
C1, C4, C7	multilayer chip capacitor	100 nF		
C2, C5, C8	tantalum capacitor	2.2 μ F		
C3, C6, C9	multilayer chip capacitor	33 pF		
C10, C11	multilayer chip capacitor	1 nF		
C12	tantalum capacitor	1 μ F		
L1, L2, L3	RF choke, 1 turn copper wire on grade 3B core	22 μ H	0.4 mm	4330 030 32221
L4	Ferroxcube coil	5 μ H		3122 108 20153
Z ₁ , Z ₂	stripline; note 1	50 Ω		

Note

1. The striplines are on double copper-clad printed circuit board with PTFE dielectric ($\epsilon_r = 2.2$), thickness $\frac{1}{16}$ inch.