

Silicon Dual Diode

BYQ28ED-150

150V/10A

DATASHEET

OEM – Philips

Source: Philips Databook 1999

Rectifier diodes ultrafast, rugged

BYQ28E, BYQ28EB, BYQ28ED series

FEATURES

- Low forward volt drop
- Fast switching
- Soft recovery characteristic
- Reverse surge capability
- High thermal cycling performance
- Low thermal resistance

SYMBOL

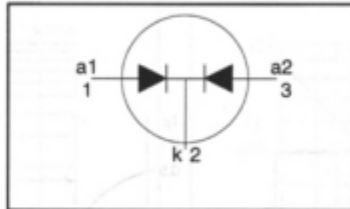

QUICK REFERENCE DATA

$$V_R = 150 \text{ V} / 200 \text{ V}$$

$$V_F \leq 0.895 \text{ V}$$

$$I_{O(AV)} = 10 \text{ A}$$

$$I_{RRM} = 0.2 \text{ A}$$

$$t_{rr} \leq 25 \text{ ns}$$

GENERAL DESCRIPTION

Dual, ultra-fast, epitaxial rectifier diodes intended for use as output rectifiers in high frequency switched mode power supplies.

The BYQ28E series is supplied in the SOT78 conventional leaded package.

The BYQ28EB series is supplied in the SOT404 surface mounting package.

The BYQ28ED series is supplied in the SOT428 surface mounting package.

PINNING

PIN	DESCRIPTION
1	anode 1
2	cathode ¹
3	anode 2
tab	cathode

SOT78 (TO220AB)

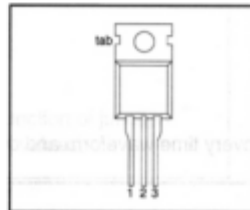

SOT404

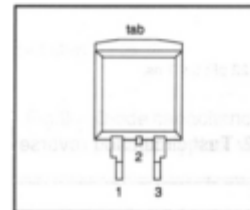

SOT428

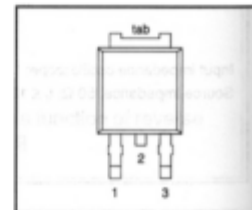

LIMITING VALUES

Limiting values in accordance with the Absolute Maximum System (IEC 134)

SYMBOL	PARAMETER	CONDITIONS	MIN.	MAX.		UNIT
V_{RRM}	Peak repetitive reverse voltage	BYQ28E/ BYQ28EB/ BYQ28ED	-	-150	-200	V
V_{RWM}	Working peak reverse voltage		-	150	200	V
V_R	Continuous reverse voltage		-	150	200	V
$I_{O(AV)}$	Average rectified output current (both diodes conducting)	square wave; $\delta = 0.5$; $T_{mb} \leq 119 \text{ }^\circ\text{C}$	-	10		A
I_{FRM}	Repetitive peak forward current per diode	square wave; $\delta = 0.5$; $T_{mb} \leq 119 \text{ }^\circ\text{C}$	-	10		A
I_{FSM}	Non-repetitive peak forward current per diode	$t = 10 \text{ ms}$	-	50		A
		$t = 8.3 \text{ ms}$	-	55		A
I_{RRM}	Peak repetitive reverse surge current per diode	sinusoidal; with reapplied $V_{RRM(max)}$ $t_p = 2 \text{ } \mu\text{s}$; $\delta = 0.001$	-	0.2		A
I_{RSM}	Peak non-repetitive reverse surge current per diode	$t_p = 100 \text{ } \mu\text{s}$	-	0.2		A
T_j	Operating junction temperature		-	150		$^\circ\text{C}$
T_{stg}	Storage temperature		-40	150		$^\circ\text{C}$

1. It is not possible to make connection to pin 2 of the SOT428 or SOT404 packages.

Rectifier diodes
ultrafast, rugged

BYQ28E, BYQ28EB, BYQ28ED series

ESD LIMITING VALUE

SYMBOL	PARAMETER	CONDITIONS	MIN.	MAX.	UNIT
V_C	Electrostatic discharge capacitor voltage	Human body model; $C = 250 \text{ pF}$; $R = 1.5 \text{ k}\Omega$	-	8	kV

THERMAL RESISTANCES

SYMBOL	PARAMETER	CONDITIONS	MIN.	TYP.	MAX.	UNIT
$R_{th(j-mb)}$	Thermal resistance junction to mounting base	per diode	-	-	4.5	K/W
		both diodes	-	-	3	K/W
$R_{th(j-a)}$	Thermal resistance junction to ambient	SOT78 package, in free air	-	60	-	K/W
		SOT404 and SOT428 packages, pcb mounted, minimum footprint, FR4 board	-	50	-	K/W

ELECTRICAL CHARACTERISTICS

All characteristics are per diode at $T_j = 25^\circ\text{C}$ unless otherwise specified

SYMBOL	PARAMETER	CONDITIONS	MIN.	TYP.	MAX.	UNIT
V_F	Forward voltage	$I_F = 5 \text{ A}$; $T_j = 150^\circ\text{C}$	-	0.8	0.895	V
		$I_F = 5 \text{ A}$	-	0.95	1.1	V
		$I_F = 10 \text{ A}$	-	1.1	1.25	V
I_R	Reverse current	$V_R = V_{RWM}$	-	2	10	μA
		$V_R = V_{RWM}$; $T_j = 100^\circ\text{C}$	-	0.1	0.2	mA
Q_{rr}	Reverse recovered charge	$I_F = 2 \text{ A}$; $V_R \geq 30 \text{ V}$; $-di_F/dt = 20 \text{ A}/\mu\text{s}$	-	4	9	nC
t_{rr1}	Reverse recovery time	$I_F = 1 \text{ A}$; $V_R \geq 30 \text{ V}$; $-di_F/dt = 100 \text{ A}/\mu\text{s}$	-	15	25	ns
t_{rr2}	Reverse recovery time	$I_F = 0.5 \text{ A}$ to $I_R = 1 \text{ A}$; $I_{RQC} = 0.25 \text{ A}$	-	10	20	ns
I_{rm}	Peak reverse recovery current	$I_F = 5 \text{ A}$; $V_R \geq 30 \text{ V}$; $-di_F/dt = 50 \text{ A}/\mu\text{s}$	-	0.5	0.7	A
V_{tr}	Forward recovery voltage	$I_F = 1 \text{ A}$; $di_F/dt = 10 \text{ A}/\mu\text{s}$	-	1	-	V

Rectifier diodes
ultrafast, rugged

BYQ28E, BYQ28EB, BYQ28ED series

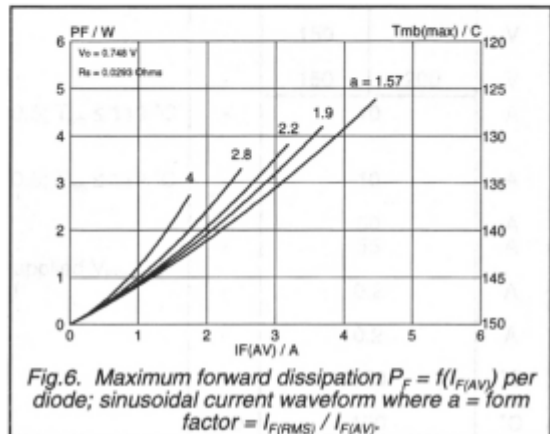
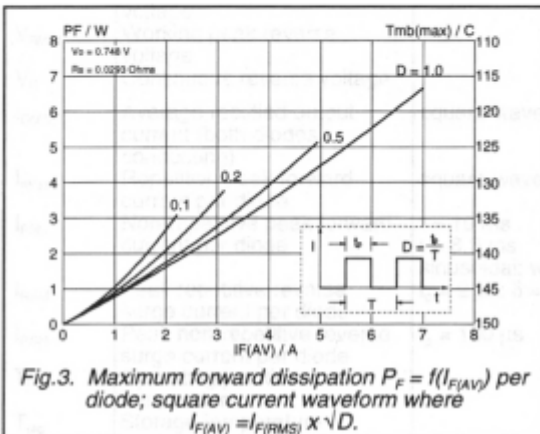
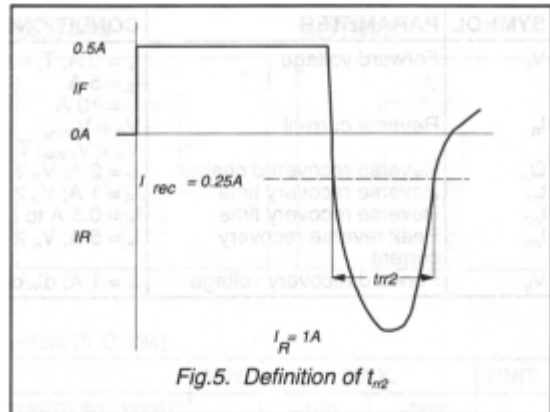
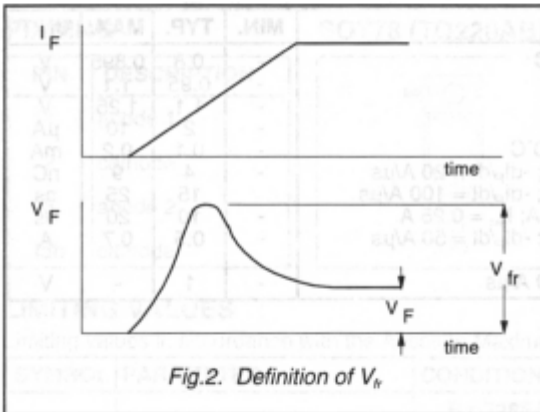
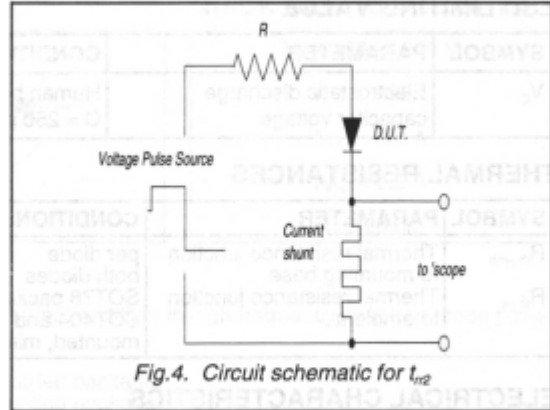
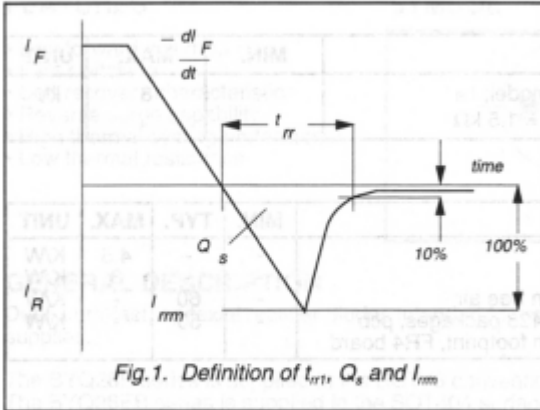

Rectifier diodes
ultrafast, rugged

BYQ28E, BYQ28EB, BYQ28ED series

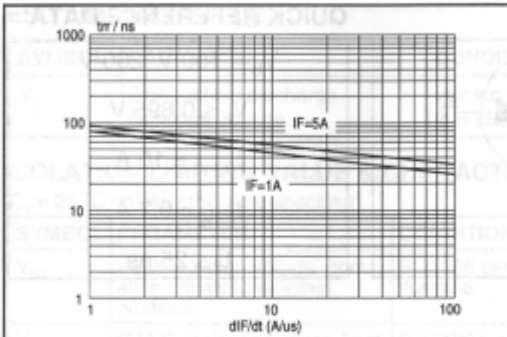

Fig.7. Maximum t_{rr} at $T_j = 25^\circ C$; per diode

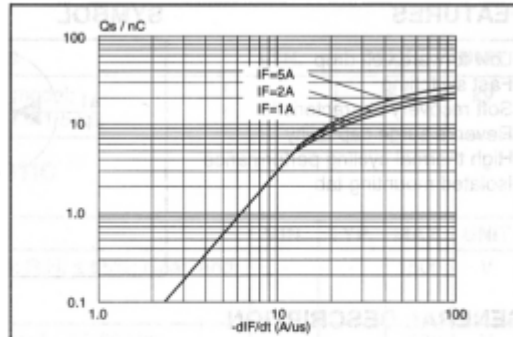

Fig.10. Maximum Q_s at $T_j = 25^\circ C$; per diode

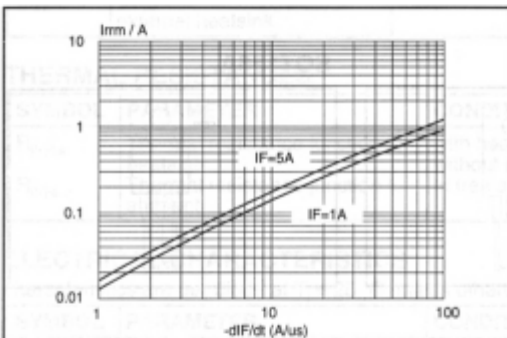

Fig.8. Maximum I_{rrm} at $T_j = 25^\circ C$; per diode

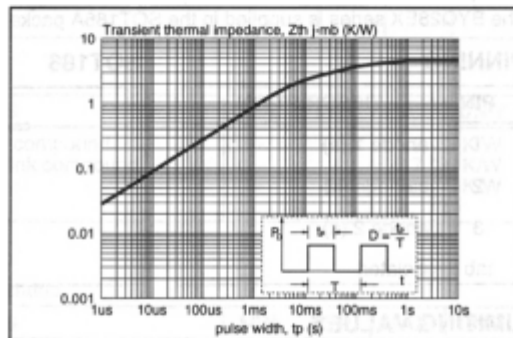

Fig.11. Transient thermal impedance; per diode;
 $Z_{th-j-mb} = f(t_p)$.

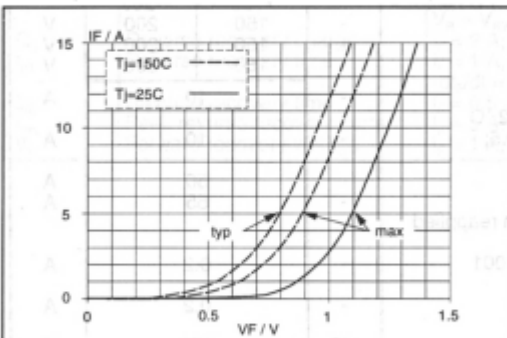

Fig.9. Typical and maximum forward characteristic
 $I_F = f(V_F)$; parameter T_j