

Bridge Rectifier

MB6S

600V / 0,5A

DATASHEET

from

www.web-bcs.com

OEM – General Semiconductor

Source: General Semiconductor Databook 1998

PATENT PENDING PATENT PENDING PATENT PENDING

MB2S THRU MB6S

MINIATURE GLASS PASSIVATED SINGLE-PHASE SURFACE MOUNT BRIDGE RECTIFIER

Reverse Voltage - 200 to 600 Volts Forward Current - 0.5 Ampere

TO-269AA

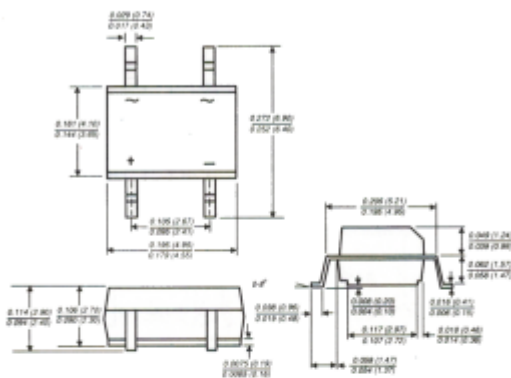

Dimensions in inches and (millimeters)

FEATURES

- ◆ Plastic package has Underwriters Laboratory Flammability Classification 94V-0
- ◆ This series is UL recognized under Component Index, file number E54214
- ◆ Glass passivated chip junctions
- ◆ High surge overload rating: 35A peak
- ◆ Saves space on printed circuit boards
- ◆ High temperature soldering guaranteed: 260°C/10 seconds at 5 lbs. (2.3kg) tension



MECHANICAL DATA

Case: Molded plastic body over passivated junctions

Terminals: Plated leads solderable per MIL-STD-750, Method 2026

Polarity: Polarity symbols marked on body

Mounting Position: Any

Weight: 0.0078 ounce, 0.22 gram

MAXIMUM RATINGS AND ELECTRICAL CHARACTERISTICS

Ratings at 25°C ambient temperature unless otherwise specified.

	SYMBOLS	MB2S	MB4S	MB6S	UNITS
Device marking code		2	4	6	
Maximum repetitive peak reverse voltage	VRRM	200	400	600	Volts
Maximum RMS voltage	VRMS	140	280	420	Volts
Maximum DC blocking voltage	VDC	200	400	600	Volts
Maximum average forward output rectified current at TA=30°C	IAV		0.5		Amp
- on glass-epoxy P.C.B. (NOTE 1)			0.8		
- on aluminum substrate (NOTE 2)					
Peak forward surge current 8.3msec single half sine-wave superimposed on rated load (JEDEC Method)	IFSM		35.0		Amps
Rating for fusing (t<8.3ms)	IFt		5.0		A²sec
Maximum instantaneous forward voltage drop per leg at 0.4A	VF		1.0		Volts
Maximum DC reverse current at rated DC blocking voltage per leg	IR		5.0		µA
			500		
Typical junction capacitance per leg (NOTE 3)	CJ		13.0		pF
Typical thermal resistance per leg	REJA		85.0		°C/W
(NOTE 1)	REJA		70.0		
(NOTE 2)	REJL		20.0		
Operating junction and storage temperature range	TJ, TSTG		-55 to +150		°C

NOTES:

- (1) On glass epoxy P.C.B. mounted on 0.05 x 0.05" (1.3 x 1.3mm) pads
- (2) On aluminum substrate P.C.B. with an area of 0.8 x 0.8 x 0.25" (20 x 20 x 6.4mm) mounted on 0.05 x 0.05" (1.27 x 1.27mm) solder pad
- (3) Measured at 1.0 MHz and applied reverse voltage of 4.0 Volts

RATINGS AND CHARACTERISTIC CURVES MB2S THRU MB6S

FIG. 1 - DERATING CURVE FOR OUTPUT RECTIFIED CURRENT

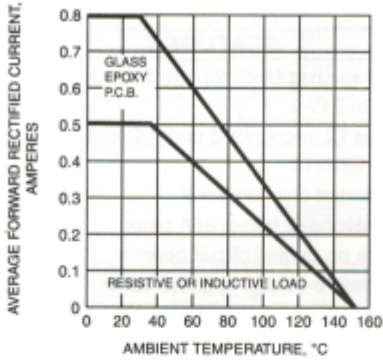

FIG. 2 - MAXIMUM NON-REPETITIVE PEAK FORWARD SURGE CURRENT PER LEG

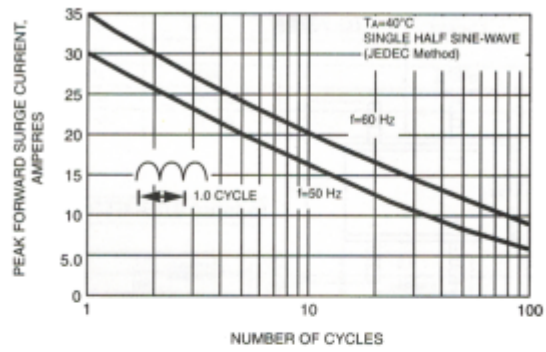

FIG. 3 - TYPICAL FORWARD VOLTAGE CHARACTERISTICS PER LEG

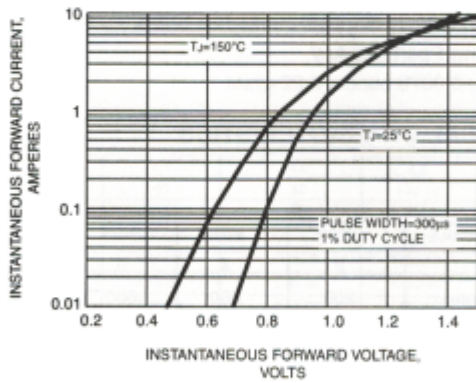

FIG. 4 - TYPICAL REVERSE LEAKAGE CHARACTERISTICS PER LEG

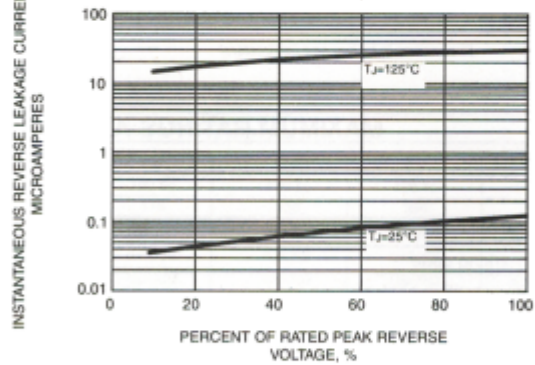

FIG. 5 - TYPICAL JUNCTION CAPACITANCE PER LEG

