

Bridge Rectifier

DF08S

800V / 1A

DATASHEET

from

www.web-bcs.com

OEM – General Semiconductor

Source: General Semiconductor Databook 1998

DF005S THRU DF10S

MINIATURE GLASS PASSIVATED SINGLE-PHASE SURFACE MOUNT BRIDGE RECTIFIER

Reverse Voltage - 50 to 1000 Volts Forward Current - 1.0 Ampere

Case Style DFS

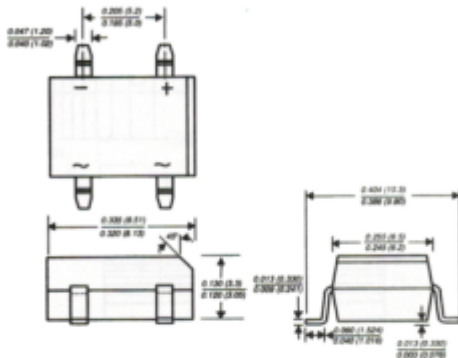

Dimensions in inches and (millimeters)

FEATURES

- ◆ Plastic package has Underwriters Laboratory Flammability Classification 94V-0
- ◆ This series is UL recognized under Component Index, file number E54214
- ◆ Glass passivated chip junctions
- ◆ High surge overload rating-50 amperes peak
- ◆ Ideal for printed circuit boards
- ◆ High temperature soldering guaranteed: 260°C/10 seconds at 5 lbs. (2.3kg) tension



MECHANICAL DATA

Case: Molded plastic body over passivated junctions
Terminals: Plated leads solderable per MIL-STD-750, Method 2026
Polarity: Polarity symbols marked on body
Mounting Position: Any
Weight: 0.04 ounce, 1.0 gram

MAXIMUM RATINGS AND ELECTRICAL CHARACTERISTICS

Ratings at 25°C ambient temperature unless otherwise specified.

	SYMBOLS	DF 005S	DF 01S	DF 02S	DF 04S	DF 06S	DF 08S	DF 10S	UNITS
Maximum repetitive peak reverse voltage	VRRM	50	100	200	400	600	800	1000	Volts
Maximum RMS voltage	VRMS	35	70	140	280	420	560	700	Volts
Maximum DC blocking voltage	VDC	50	100	200	400	600	800	1000	Volts
Maximum average forward output rectified current at TA=40°C (NOTE 2)	I(AV)	1.0							Amp
Peak forward surge current single half sine-wave superimposed on rated load (JEDEC Method) TJ=150°C	IFSM	50.0							Amps
Rating for fusing (t < 8.3ms)	It	10.0							A'sec
Maximum instantaneous forward voltage drop per leg at 1.0A	VF	1.1							Volts
Maximum DC reverse current at rated DC blocking voltage per leg	IR	5.0 500							µA
Typical junction capacitance per leg (NOTE 1)	CJ	25.0							pF
Typical thermal resistance per leg (NOTE 2)	REJA REJL	40.0 15.0							°C/W
Operating junction and storage temperature range	TJ, TSTG	-55 to +150							°C

NOTES:

- (1) Measured at 1.0 MHz and applied reverse voltage of 4.0 Volts
- (2) Units mounted on P.C.B. with 0.51 x 0.51" (13 x 13mm) copper pads

RATINGS AND CHARACTERISTICS CURVES DF005S THRU DF10S

